



BLOOD-DRAWING CHAIR C O L L E C T I O N

OWNER'S OPERATING & MAINTENANCE MANUAL



PLEASE DO NOT DISCARD THIS MANUAL! KEEP IT FOR FUTURE REFERENCE AND TRAINING

TABLE OF CONTENTS

PLEASE READ AND FAMILIARIZE YOURSELF WITH **ALL** INSTRUCTIONS BEFORE USING THIS PRODUCT!

If you have trouble understanding these instructions contact your dealer or Winco customer support, (800) 237-3377 before attempting to use this product; otherwise injury may occur.

Winco assumes no responsibility for damage or injury caused by improper assembly, installation, use, or maintenance of these products.

Table of Contents

Winco Contact Information	3
Limited Warranty.....	3
Important Safety Precautions.....	4
Intended Use Statement	4
Transportation, Storage, Handling and Disposal Instructions.....	4
Weight Capacity - Cleaning Information-.....	5
Tools Needed -	5
Seat Installation (Models 2570-2575, 2578).....	6
Arm & Glide Foot Installation (All Models).....	7
Cabinet Assembly/Installation (Models 2570, 2572, and 2574)	8
Seat Height Set-up & Adjustment Instructions (2578).....	9
Optional Pivot Arm Configuration (PR & P2 options).....	10



WINCO CONTACT INFORMATION & WARRANTY



5516 Southwest 1st Lane
Ocala, FL 34474
1-800-237-3377 / 352-854-2929 / Fax: 352-854-9544
e-mail: customerservice@wincomfg.com
Visit us on the web: www.wincomfg.com

Limited Warranty

TERMS

Winco Mfg., LLC. warrants this product to be free of manufacturer's defects in material and workmanship, provided that the product is used according to normal operating conditions and proper maintenance intended by manufacturer. This warranty is available only to the original retail purchaser, is non-transferable and commences on the date of retail sale; proof of purchase required.

LIMITED ONE YEAR COMPLETE PRODUCT WARRANTY: Winco Mfg., LLC warrants the complete product for one (1) year. At Winco Mfg., LLC. sole discretion, it may repair or replace any components freight free that are found to be defective during the first year. Winco Mfg., LLC. shall not be liable for any labor, or any other costs incurred as a result of or in conjunction with a warranty claim.

LIMITED THREE YEAR WARRANTY: Winco Mfg., LLC warrants recliner mechanisms, electrical components, vinyl panels and Vinyl on upholstered parts [from cracking or delaminating] pressurized gas springs, and casters, when new, for a period of three (3) years. At Winco Mfg., LLC.'s Sole discretion, it may repair or replace components found to be defective. Winco Mfg., LLC. shall not be liable for any labor, shipping or any other costs incurred as a result of or in conjunction with a warranty claim.

LIMITED LIFETIME CHAIR FRAME WARRANTY: Winco Mfg., LLC warrants steel and aluminum base frames for all products, when new, for the lifetime of the original purchaser. This limited warranty does not apply to paint/finish or any components attached to the frame such as; upholstery, foam, casters, mechanisms or related parts that are covered under above warranties. Winco Mfg., LLC shall not be liable for any labor, shipping or any other costs incurred as a result of or in conjunction with a warranty claim.

The purchaser's exclusive remedy under this warranty shall be limited to such repair or replacement of defective components at Winco Mfg., LLC sole discretion. For warranty service, contact the dealer that the product was originally purchased from or Winco Mfg., LLC directly.

EXCLUSIONS

There are no other warranties, conditions, representations or guarantees, express or implied, made or intended by Winco Mfg., LLC and all other warranties, conditions, representations or guarantees including any warranties, conditions, representations or guarantees under any Sale of Good Act or Like legislation or statute is hereby expressly excluded. Any and all other implied warranties shall not extend beyond the duration of the express warranty. Liability for incidental or consequential damages is excluded to the extent permitted by law. Some states do not allow the exclusion or limitation so the above limitation or exclusion may not apply to you. This warranty gives you specific legal rights. In addition you may also have other rights, which vary from state to state.

GENERAL PROVISIONS

No warranty herein contained or set out shall apply when damage or repair is caused by any of the following:

1. Damage in transit.
2. Accident, alteration, abuse or misuse of product i.e. exceeding weight capacities, applying inordinate pressure to footrest/leg rest, use in Mental Health facilities, like institutions or, any unintended use of the product or use in unintended environments (i.e. outdoor, showers, MRI rooms, etc..)
3. Fire, water damage, theft, war, riot, hostility, acts of God.

*Examples contained in this list are not to be construed as all-inclusive.
Design, appearance, parts, & construction are subject to change without notice*



IMPORTANT - PLEASE READ



1. READ AND FOLLOW ALL DIRECTIONS.
2. Chair should ALWAYS be positioned on level surface.
3. Children MUST be supervised at all times when near chair.
4. DO NOT stand on chair.
5. DO NOT use movable arm as a restraint device
6. DO NOT put hands, feet or clothing into any openings when changing positions on chair
Attendant MUST confirm that users arms, legs, hands and feet are safe while changing chair positions or SERIOUS INJURY MAY RESULT.
7. STAY CLEAR of moving parts.
8. DO NOT use chair for transporting in or with ANY type of vehicle or trailer. Winco chairs have not been tested or approved for use by an occupant in any type of vehicle or trailer.
9. NEVER use the chair arms or backrest as a seat; SERIOUS INJURY or damage may occur.
10. Failure to completely tighten the seat mounting screws COULD RESULT IN INJURY.
11. Periodically check the tightness of all nuts, bolts and screws.
12. Immediately REMOVE FROM SERVICE; Any chair with broken parts, torn upholstery, or other mechanical or visible damage.
13. USE ONLY WINCO AUTHORIZED REPLACEMENT PARTS.
14. NEVER EXCEED the recommended weight capacity - see pages 6.
15. SAVE THESE INSTRUCTIONS for future reference and training.

Intended Use Statement

Intended Use: The Blood Drawing Chair is a chair intended for use in medical settings. It is designed without wheels and is not electrically powered. It is intended for use in blood donation, collection, or sampling procedures.

Transportation, Storage, Handling and Disposal Instructions

The product should be **transported** in factory packaging, inside an appropriate medium for the destination, i.e., air/sea cargo containers. The product should be **stored** in an environment that will inhibit rust/mold formation. Winco does not recommend leaving the product in the factory packing in excess of 3 months. The product should always be **handled** in a manner consistent with the user instructions, and in a manner to prevent contamination after each use. The product has many recyclable components and to the extent practical, all efforts should be used to recycle responsibly. Otherwise, the product components shall be **disposed** of in accordance with local statues.



Weight Capacities

ALWAYS refer to the weight capacity label on your chair.

In all cases the labeling on the chair at the time of delivery is the correct rating for your chair. Weight rating should not be exceeded.

General Care & Cleaning

GENERAL CARE & CLEANING:

- OCCASIONALLY lubricate pivot points on the Pivoting Arm mechanisms with a lubricant approved by your facility.
- Periodically inspect tightness of all screws, bolts, nuts, or other fasteners.

Winco furnishings are built to provide durable reliable service when properly cared for.

In general all of our products should be 1) Cleaned 2) Rinsed 3) Allowed to air dry.

It is important to note that disinfecting a product is not the same as cleaning the product. Disinfectants alone will not provide adequate cleaning, they do not have grease or oil cutting properties to remove grime or hair and skin oils. Over time, the appearance and feel and performance of your upholstery may diminish if not cleaned properly

CLEANING:

Remove grime, hair and body oils; Your furnishings should be cleaned with mild soap & water solution and a damp cloth on a regular basis (especially where skin & hair make contact with upholstery). Avoid harsh detergents that could damage the upholstery or finish of your recliner. If the furnishing is disinfected with bleach, it MUST be wiped off using only clean water on a damp cloth and then be allowed to air dry. Failure to rinse upholstery with clean water can result in a build-up of residues over time that can dry out the upholstery and cause changes to the look and feel of the upholstery and eventually can lead to cracking.

For Custom or non-standard vinyl, please refer to manufacturers instructions for cleaning.

Tools Needed

Models 2570, 2571, 2572, 2573, 2574, and 2575:

- Multiple size wrench included (or your own 5/16, 3/8" & 7/16" or adjustable wrenches)
- Phillips-head screwdriver
- Scissors or box cutter
- Powered tools not recommended

Models 2578:

- Multiple size wrench included (or your own 7/16" or adjustable wrench)
- 3/16" Hex "Allen" wrench included
- "Phillips-head" screwdriver – for checking tightness of all screws after shipping
- Scissors or box cutter
- Powered tools not recommended.

Before you begin:

- Check your product for any shipping damage, remove all hardware and packing material that was secured for shipping.
- You may have to cut down the cardboard container with a box cutter to access the product. Use CAUTION to avoid cutting your skin or damaging the product.
- If you have questions about your assembly or if the product is damaged in ANY way, please contact Winco Customer Support at 1-800-237-3377.



Seat Installation 2570-2575, 2578

WARNING

Failure to completely tighten the seat mounting screws
COULD RESULT IN SERIOUS INJURY.

Models 2570 and 2571 (FIG. 1)

1. Position **Chair Frame** in upright position. Check tightness of all installed screws, bolts, nuts and other fasteners in case they loosened during shipping.
2. Align the mounting holes on the plastic **Seat** with the **Seat Support** holes. Hole spacing of Seat and Seat Supports will be narrower toward front of chair. Seat can only be installed facing one direction. **FIG 1**
3. Using the included wrench (or your own 5/16" tool), install the (4) 705300 **Seat Screws** through the holes of Chair Frame, and into the four (4) holes on bottom of the plastic Seat. Make sure screws are completely tightened. **FIG 1**

NOTE: These "special" screws **MUST BE USED** for maximum grip in this seating application. They can be slightly difficult to "get started" in the holes on the plastic Seat.

TIP: Use even pressure and, if available, a "5/16" nut-driver" (screw-driver-type handle with a 5/16" socket on end) however, this task can be accomplished with the included wrench.

Models 2572, 2573, 2578 (FIG. 2)

1. Position **Chair Frame** in upright position. Check tightness of all installed screws, bolts, nuts and other fasteners in case they loosened during shipping.
2. Align the screws on bottom of the **Seat Assembly**, with the **Seat Support** holes. (Hole spacing of Seat Supports will be narrower toward front of Chair). **Seat** can only be properly installed facing one direction. Be sure that all (4) Seat Screws go completely through the Seat Support straps on chair frame.
3. Install (4) **lock nuts** to the screws on the **Seat Assembly** and completely tighten with 7/16" wrench.

Models 2574 and 2575 (FIG. 3)

1. Position **Chair Frame** in upright position. Check tightness of all installed screws, bolts and nuts in case they loosened during shipping.
2. Align the screws on bottom of the **Seat Assembly**, with the **Seat Support** holes. **FIG 3**

NOTE: Seat Supports are angled to give the seat a very slight recline angle. The **FRONT** of seat should be positioned toward the **HIGHER** end of the strap. **FIG 3**

Be sure that all (4) Seat Screws go completely through the Seat Support straps on chair frame.

3. Install (4) **lock nuts** to the screws on the **Seat Assembly** and completely tighten with 7/16" wrench.

FIG. 1

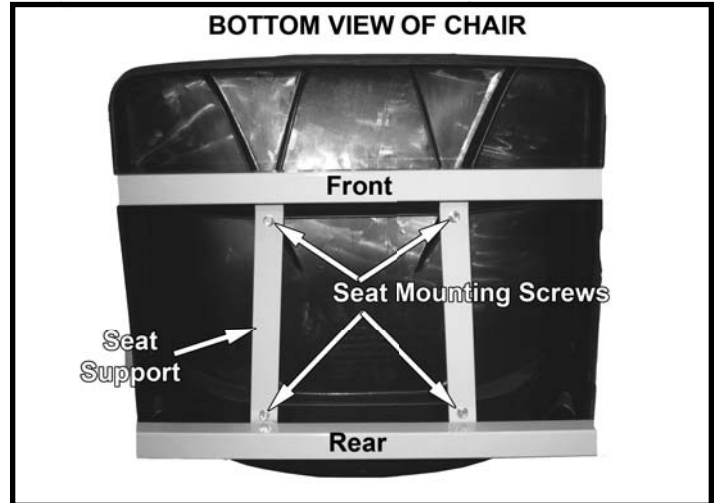

FIG. 2



FIG. 3



Arm Installation - All models

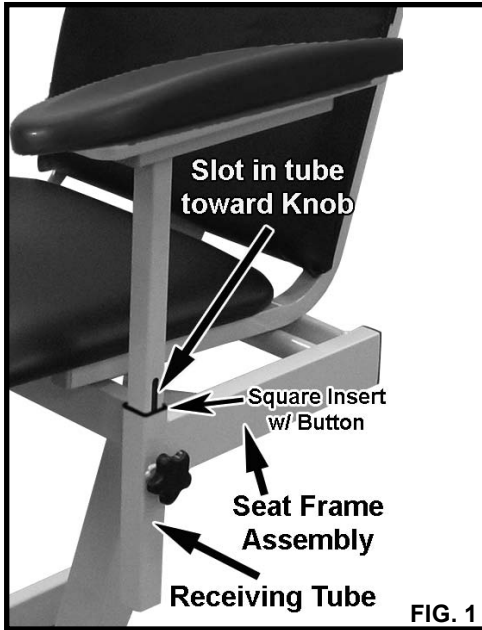

1. If the **Arm Assembly** has not yet been installed, insert it into the **Receiving Tube** on **Seat Frame Assembly**. (This applies to any style arm assembly)

•ALWAYS make sure that the slot in the Arm Assembly faces the Knob installed on the receiving tube. (FIG. 1)

2. Then adjust the arm to the desired height and tighten the knob. Screw the Knob into the Slot. This will “capture” the arm and keep it from being able to be pulled out of the frame accidentally.

DO NOT OVERTIGHTEN - The Knob will NOT need to be extremely tight to effectively hold arms in position.

Glide Foot Installation - All models

Glide Foot Installation

1. Place chair on side and install (4) **Glide Feet** in threaded holes on the bottom of the **Chair Frame** (FIG. 6 & 7). Lift & position the chair to the upright position, with Glide Feet on a level floor.
2. If the Chair Frame does not sit level on the floor, loosen one or two of the Glide Feet individually and adjust until the Chair Frame is level.

FIG 6 & 7
2570-2571-2572
2573-2574-2575

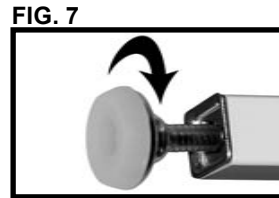
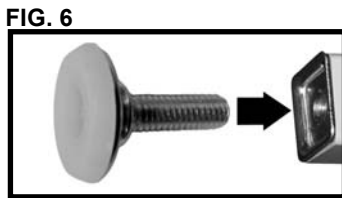

FIG 6a & 7a
2578

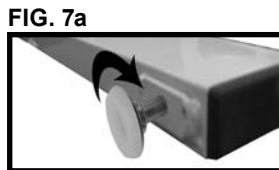
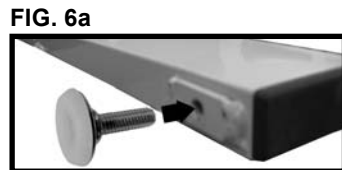
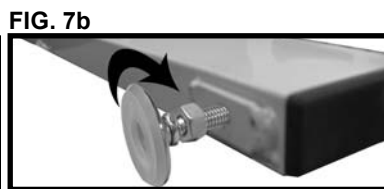
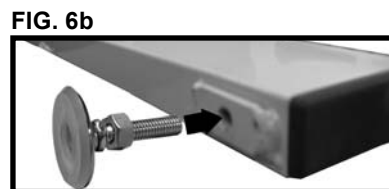

FIG 6b & 7b
2588



Cabinet Assembly Models 2570, 2572, & 2574

1. Remove the cabinet assembly from the frame. (FIG. 1)
2. Remove packaging materials from cabinet assembly.
3. The cabinet installs on the Patient LEFT side of the chair: See (FIG. 2) below and insert the cabinet assembly into the receiving tube. •ALWAYS make sure that the slot in the Arm Assembly faces the Knob installed on the receiving tube. (FIG. 2)
4. Adjust the Cabinet to desired height and tighten Knob.
5. CABINET INSTALLATION COMPLETE. (FIG. 3).

BE SURE to tighten the black knob to secure the cabinet - even if no height adjustment is made. This will secure cabinet for use.

6. To remove drawer, open drawer until the drawer stops. Using your finger, locate the drawer stop tab mounted to the bottom of the drawer top, press the tab against the drawer top and slide the drawer past the tab. (FIG.4)
7. To install the drawer, insert the rear part of the drawer past the drawer stop, then slide the drawer into the frame. (FIG.5)

Special note for chairs with “PR or P2” option:

If your chair was ordered with a “PR” (Pivot Arm option) then you are finished with the Cabinet install. Otherwise proceed to “PR & P2” Installation Instructions on Page 10.

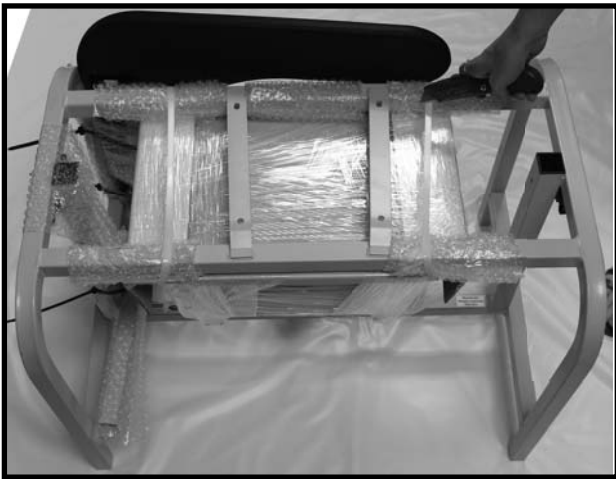

FIG. 1



FIG. 2



FIG. 3



FIG. 4

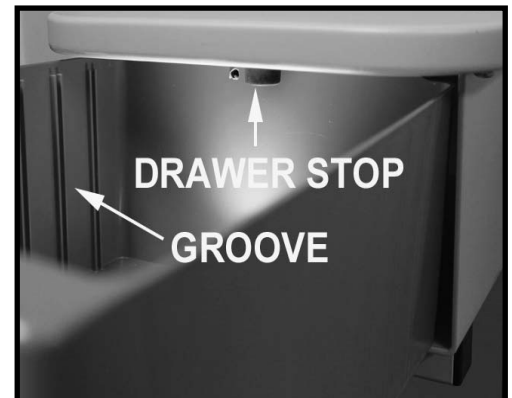

FIG. 5

Models 2578 Seat Height Set-up and/or Adjustment

The seat height of your 2578 Designer Blood Drawing Chair can be adjusted during setup.

CAUTION: The **Seat Assembly** is VERY HEAVY. To adjust the height; the chair must be supported by someone that can LIFT OVER 50 LBS.

1. **Use two people:** Use the included 3/16" Hex (Allen) wrench and the included "multi-size" wrench to remove the **nut, lockwasher & shoulder bolt** from the square post on the **Base Assembly**.
2. Align the **Seat Bracket** over **Seat Post**.
3. **IMPORTANT:** Have your helper grasp the seat by the metal seat frame to hold the **Seat Assembly** steady to prevent it from dropping;
4. Slowly lower the Seat Bracket down onto the Seat Post until the hole in the Seat Bracket is aligned with a hole on the post for the desired seat height. Re-install the shoulder bolt and locknut into one of the aligned sets of holes to obtain desired seat height. **TIGHTEN THE NUT & LOCKWASHER ON SHOULDER BOLT**

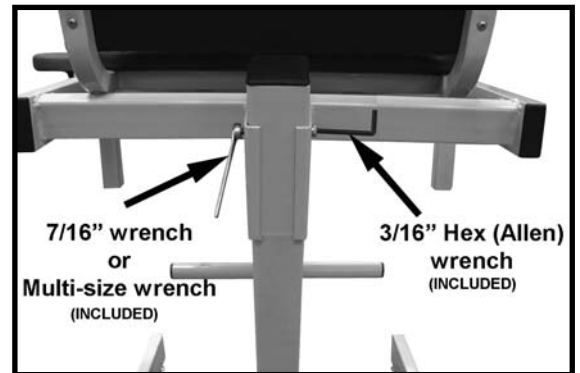
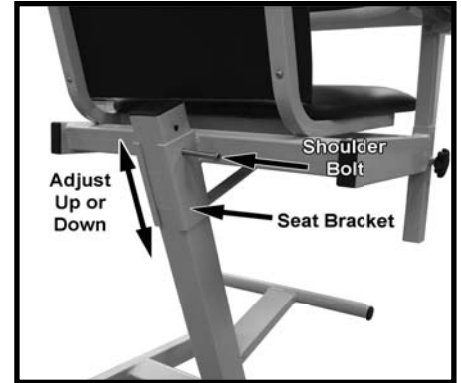
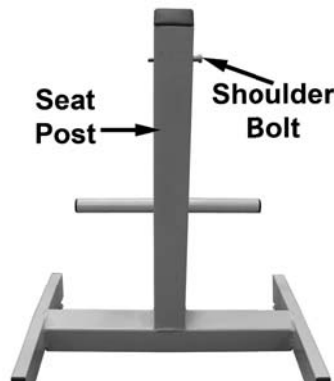

WARNING

**CHAIR MUST NOT BE USED WITHOUT SHOULDER BOLT, LOCKWASHER AND NUT COMPLETELY TIGHTENED
– INJURY COULD RESULT –**

“PR” & “P2” - Optional Pivot Arm (see models listed below)

****If ordered with “L” shaped arm follow arm assembly instructions on page 7****

Models 2570-2571-2572-2573-2574-2575 PR and 2571-2573-2575 P2

Your Pivot Arm assembly may be configured in one of two (2) directions:

- Pivot point located near the back of chair – This will provide arm support that is straight or at a slight angle to the side of the patient (standard position).
- Pivot point located near front of chair – This will provide arm support across the front of the patient’s body.

1. If you wish to change the standard setup of the **Pivot Arm (FIG. 1)** so that the pivot point is toward the front of the chair; Proceed to the next step – IF NOT – skip this step.
–If ordered Q Option, you can choose which Pivot Arm(s), if any, you wish to alter.



This change can be made before or after **Arm Assembly** is installed on chair.

2. Use a Phillips or #2 square bit screwdriver to remove the (4) **wood screws** on underside of arm assembly that hold the **Pivot Arm assembly** onto the steel **Arm Support**.

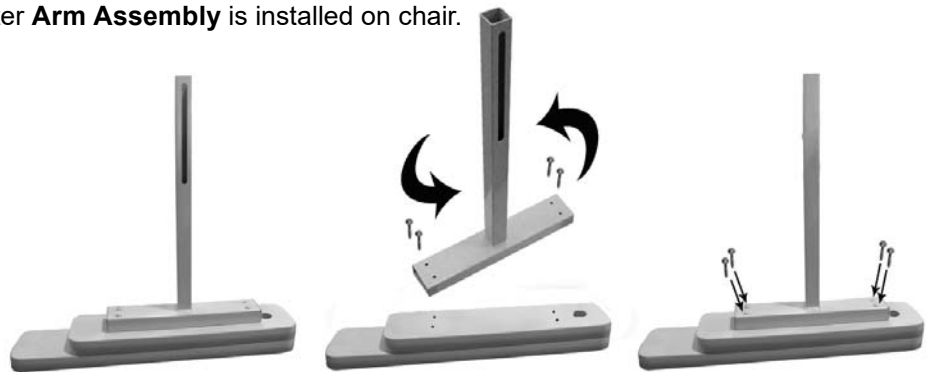

FIG. 1

FIG. 2

FIG. 3

3. After (4) **wood screws** are removed; Rotate **Pivot Arm assembly** 180 degrees (**FIG. 2**); Re-install (4) **wood screws** to secure arm in the new position (**FIG. 3**).

Models 2578 PR & P2

1. If you wish to change the standard setup of the **Pivot Arm** so that the pivot point is toward the front of the chair; Proceed to the next step – IF NOT – skip this step.
–If ordered P2 Option, you can choose which Pivot Arm(s), if any, you wish to alter.

This change can be made before or after Arm Assembly is installed on chair.

2. Use a Phillips or #2 square bit screwdriver to remove the (4) **wood screws** on underside of arm assembly that hold the **Pivot Arm assembly** onto the steel **Arm Support** (**FIG. 4**).
3. After (4) **wood screws** are removed; Rotate **Pivot Arm assembly** 180 degrees (**FIG. 5**); Re-install (4) **wood screws** to secure arm in the new position.
4. If necessary, follow “Arm Installation Instructions” on page 7.

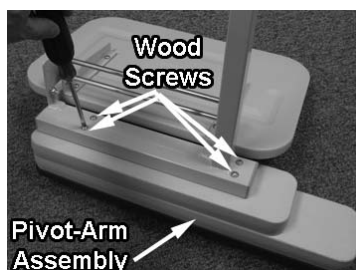

FIG. 4

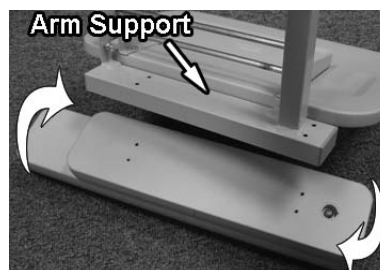

FIG. 5



OUR PRODUCTS

Other Quality Winco Furnishings You May Be Interested In:



Clinical Recliners



Exam Tables



Convalescent (LTC) Recliners

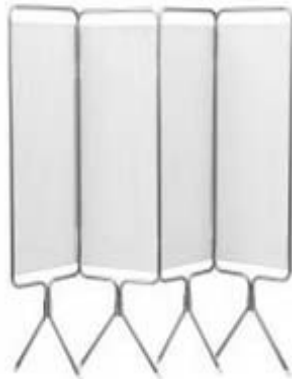

Privacy Screens



Phlebotomy Chairs



Specialty Chair Stretcher-Chair



Stools



Oncology and Dialysis Chairs

Visit us online at www.wincomfg.com



5516 Southwest 1st Lane
Ocala, FL 34474
1-800-237-3377 / 352-854-2929 / Fax: 352-854-9544
e-mail: *customerservice@wincomfg.com*
Visit us on the web: *www.wincomfg.com*